

CP COLOR 575

Il nuovo cambiacolori professionale per esterni - IP65

Clay Paky presenta CP Color 575, un mix perfetto fra esperienza e tecnologia, che vi stupirà per la straordinaria potenza e qualità del colore.

Disegnato per illuminare facciate di palazzi, monumenti, fontane, colonnati, elementi architettonici, storici, artistici e d'arredo urbano, il CP Color 575 ha un grado di protezione IP65.

Può impiegare le lampade HSD 575 o HSR 575, entrambe di nuovissima concezione, capaci di offrire una grande luminosità.

CP Color 575 offre color mixing CMY, con l'impiego di filtri dicroici selezionati per infinite tonalità di colore uniforme, e dimmer meccanico da 0 a 100% per l'oscuramento graduale del fascio di luce.

In opzione, Clay Paky offre un filtro diffusore che apre il fascio fino a 80° mantenendo massima uniformità del fascio anche a distanza ravvicinata, un filtro frost "400", un filtro frost "90" e un filtro ovalizzatore orientabile, tutti di diametro 205 mm ed applicabili direttamente sul corpo del prodotto.

Gli operatori possono scegliere se programmare il proiettore tramite centralina (segnale DMX 512) oppure impiegando le funzioni automatiche previste (funzionamento "Stand Alone"),

attraverso una vasta gamma di pratici "chase" residenti nel sistema.

CP Color 575 è orientabile su un angolo di 90°, e può funzionare in qualsiasi posizione di lavoro.

The new professional color changer for outdoors - IP65

Clay Paky presents CP Color 575, a perfect mix of experience and technology which will stagger you with outstanding power and color quality.

Designed for illuminating facades, monuments, fountains, colonnades and other architectural, historical, artistic and urban details, CP Color 575 has a protection rating of IP65.

It can be fitted with an HSD 575 lamp or an HSR 575 lamp, both state-of-the-art products offering high luminosity.

CP Color 575 features CMY color mixing, with selected dichroic filters for infinite shades of uniform color and a 0 to 100% dimmer for gradual dimming of the beam. Clay Paky offers an optional revolving ovalising filter, a frost filter "400", a frost filter "90", a diffusion filter which opens the beam to an angle of 80° whilst maintaining maximum uniformity of light even from a close distance.

All are 205 mm in diameter and can be fitted onto the body of the projector.

Operators can choose whether to program the projector from a lighting desk (DMX 512 signal) or using the automatic functions ("Stand Alone" mode), with a wide choice of handy chases.

CP Color 575 revolves up to 90° and works in any position.



PROFESSIONAL SHOW LIGHTING

CP COLOR 575: DATI TECNICI / TECHNICAL INFORMATION

Alimentazioni disponibili

- 230 V 50 Hz • 240 V 50 Hz • 208 V 60 Hz
- 200 V 50 Hz • 200 V 60 Hz

Potenza assorbita

650VA a 230V 50 Hz (rifasamento 70 µf).

Lampada

A ioduri metallici alimentata tramite speciale alimentatore incorporato.

- Tipo HSD 575 W.
- Temperatura colore: 7.200 K.
- Vita media: 3.000 ore.
- Tipo HSR 575 W.
- Temperatura colore: 6.000 K.
- Vita media: 1.000 ore.

Motori

N. 8 motori passo-passo, funzionanti a micropassi, totalmente controllati da microprocessore.

Gruppo ottico

- Riflettore parabolico ad elevata resa luminosa.

Canali: n. 4 canali di controllo.

Ingressi: DMX 512.

Grado di protezione: IP65.

Marchatura CE

Conforme alle Direttive dell'Unione Europea di Bassa Tensione 73/23 e Compatibilità Elettromagnetica 89/336.

Corpo

- In alluminio pressofuso ed acciaio.
- Verniciatura a polveri epossidiche.
- Trattamento speciale anticorrosione.

Posizione di lavoro

Funzionamento in qualsiasi posizione.

Peso: 33 kg.

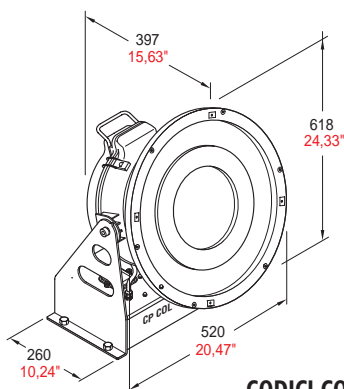

Power supplies available

- 230 V 50 Hz • 240 V 50 Hz • 208 V 60 Hz
- 200 V 50 Hz • 200 V 60 Hz

Input power

650VA at 230V 50 Hz (PFC of 70 µf).

Lamp

Discharge lamp with built-in power supply unit.

- Tipo HSD 575 W.
- Color temperature: 7,200 K.
- Average life: 3,000 h.
- Tipo HSR 575 W.
- Color temperature: 6,000 K.
- Average life: 1,000 h.

Motors

8 step motors, operating with microsteps, totally controlled by a microprocessor.

Optical unit

- Parabolic reflector with a high luminous efficiency.

Channels: 4 control channels.

Inputs: DMX 512.

Protection rating: IP65.

CE Marking

In conformity with the European Union Low Voltage Directive 73/23 and Electromagnetic compatibility Directive 89/336.

Body

- In die-cast aluminium and steel.
- Epoxy powder painting.
- Special anti-corrosion treatment.

Working position

Functioning in any position.

Weight: 33 kg (72 lbs 10 ozs).

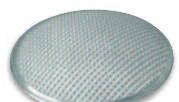

Filtro diffusore / Diffusion filter



Filtro frost "90" / Frost filter "90"

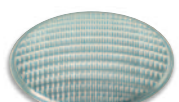

Filtro ovalizzatore / Ovalising filter



Filtro frost "400" / Frost filter "400"

CODICI COMMERCIALI / SALES CODES

C11198 CP Color 575

L10066 Lampada HSD 575 W / HSD 575 W lamp

L10067 Lampada HSR 575 W / HSR 575 W lamp

080382/001 Filtro diffusore Ø 205 mm / Diffusion filter 205 mm Ø

080383/001 Filtro ovalizzatore Ø 205 mm / Ovalising filter 205 mm Ø

080392/001 Filtro frost "90", Ø 205 mm / Frost filter "90", 205 mm Ø

080392/002 Filtro frost "400", Ø 205 mm / Frost filter "400", 205 mm Ø

CANALI / CHANNELS

1 - Cyan 2 - Magenta

3 - Yellow 4 - Dimmer

Diagrammi di luminosità / Luminosity diagrams

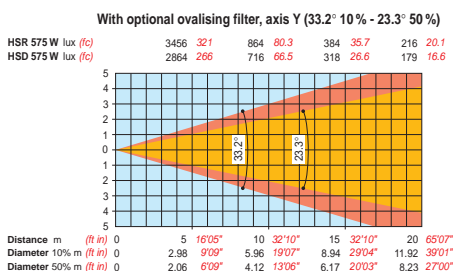
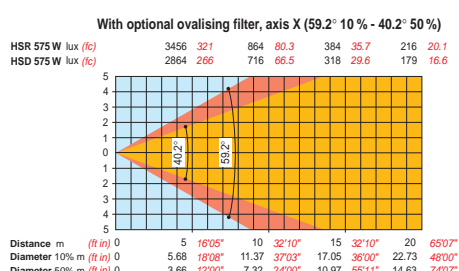
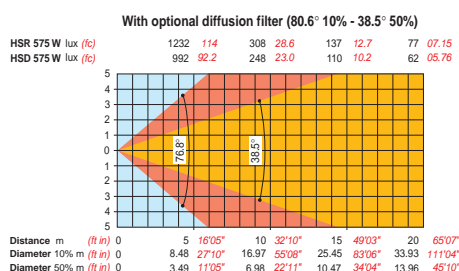
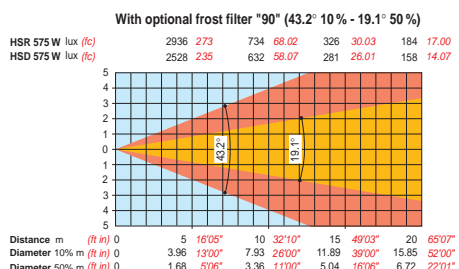
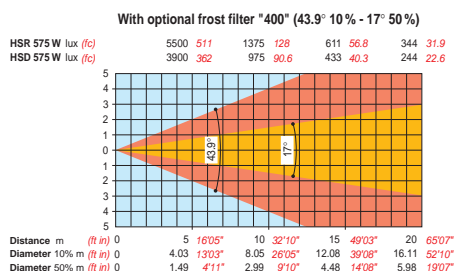
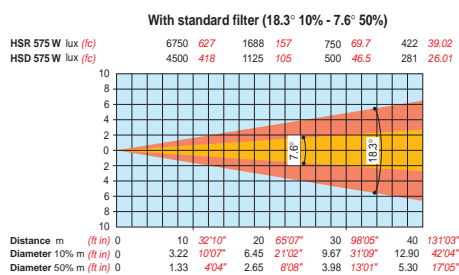

Legenda: diametro 10% - 50%: valori del diametro del fascio luminoso corrispondenti al 10% e al 50% dell'illuminamento massimo.

Key: diameter 10% - 50%: light beam diameter corresponding to 10% and 50% of maximum illuminance.

CLAY PAKY s.p.a. Via Pastrengo, 3/b - Seriate (BG) Italy
Tel. +39-035-654311 - Fax +39-035-301876
e-mail: cp.sales@claypaky.it - www.claypaky.it



PROFESSIONAL SHOW LIGHTING